

EDITION	DESCRIPTION	DRAWN	DATE
	INITIAL RELEASE		02/21/03

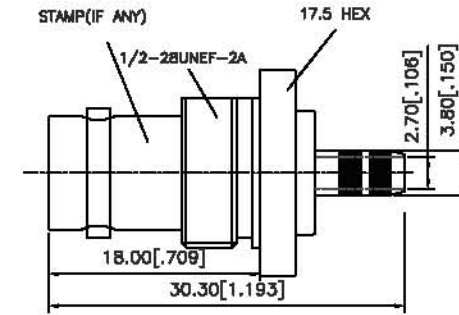

NOTE: 1. CRIMPED FERRULE HEX CRIMP SIZE .178"
 2. CRIMPED CONTACT PIN. HEX CRIMP SIZE .068"

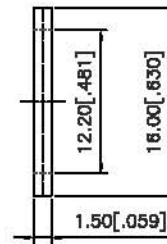
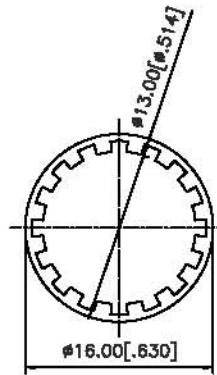
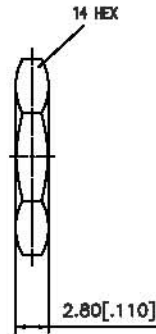
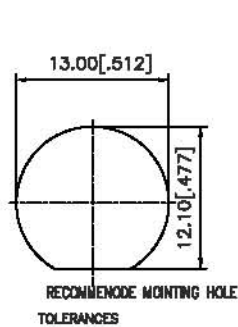
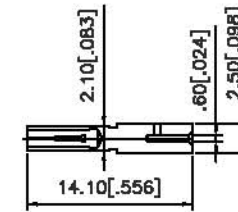
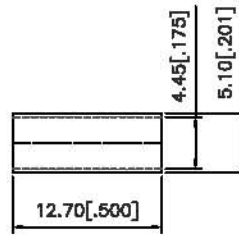
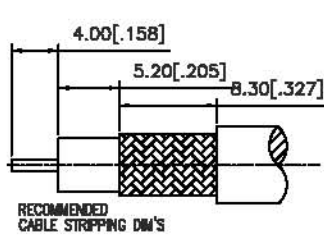

TITLE BNC BULKHEAD CRIMP JACK
(FOR BELDEN 8218 CABLE)

Edit Code. BNCFS00107G7500-1

CHECKED J. Lin

DRAWER Eddie

TOLERANCES

DIMENSIONS ARE IN MILLIMETER

UNLESS OTHERWISE SPECIFIED
 TOLERANCES FOR INCHES ARE
 0.5-8mm ±0.2mm
 8-30mm ±0.1mm
 30-120mm ±0.08mm
 UNLESS OTHERWISE SPECIFIED
 TOLERANCES FOR INCHES ARE
 .020-.315 ±0.007"
 .315-1.180 ±0.015"
 1.180-4.724 ±0.020"

FILE NO. C: EDITION: A DATE 02/24/03 SCALE NA UNIT MM

7	FERRULE	1	COPPER	NICKEL
6	HEX NUT	1	BRASS	NICKEL
5	LOCK WASHER	1	BRASS	NICKEL
4	GASKET	1	RUBBER	RED
3	CONTACT PIN	1	PHOS. BRONZE	GOLD
2	INSULATOR	1	TEFLON	NATURAL
1	Body	1	BRASS	Nickel
NO	Description	Qty	Material	Finish