

EDITION	DESCRIPTION	DRAWN	DATE
	MODIFY DESCRIPTION		03/18/05
	UPDATE DRAWING FORMAT		03/18/05

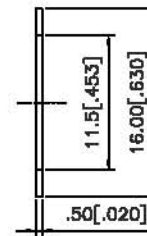

NOTES:  
1. CRIMPED CONTACT PIN HEX CRIMP SIZE .100" OR SOLDER.

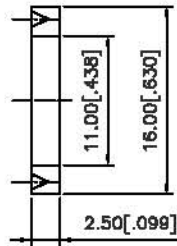
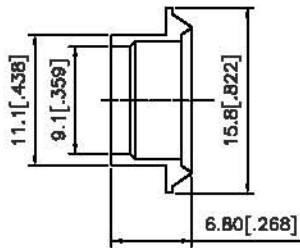
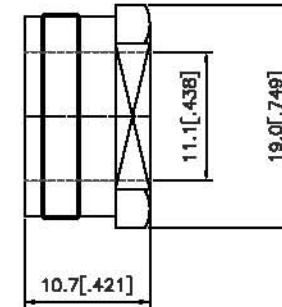
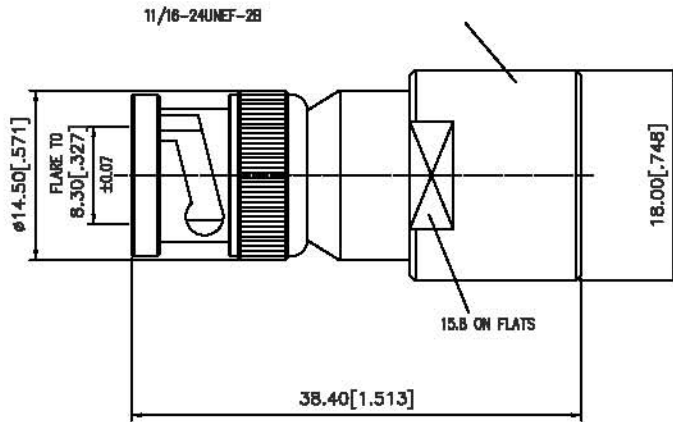
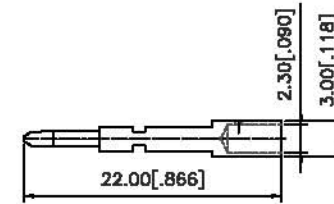
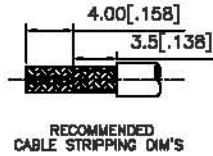

TITLE BNC CRIMP PLUG  
(RG-8/U,213/U,214/U CABLE)

Edit Code. BNCMS00201B5000-1

CHECKED J. Lin

DRAWER Eddie

TOLERANCES

DIMENSIONS ARE IN MILLIMETER

UNLESS OTHERWISE SPECIFIED  
TOLERANCES FOR INCHES ARE  
0.5-8mm±0.2mm  
8-30mm±0.1mm  
30-120mm±0.05mm  
UNLESS OTHERWISE SPECIFIED  
TOLERANCES FOR INCHES ARE  
.020-.315=±0.007"  
.315-1.180=±0.015"  
1.180-4.724=0.020"

FILE NO. C:

EDITION: A DATE 03/18/05

SCALE NA UNIT MM

7	NUT	1	BRASS	Nickel
6	WASHING	1	BRASS	Nickel
5	GASKET	1	SILICONE	RED
4	BRAID CLAMP	1	BRASS	Nickel
3	CONTACT PIN	1	PHOS. BRONZE	GOLD
2	INSULATOR	1	TEFLON	NATURAL
1	SHELL/Body	1	BRASS	Nickel
NO	Description	Qty	Material	Finish